

your global specialist

We have a solution
for automatic lubrication.

Klübermatic lubricant dispensers



We have a solution for automatic lubrication

Klübermatic lubricant dispensers

Klübermatic: an overview

Lubricant dispensers are pieces of equipment that release lubricant. They supply the lubrication point with a set quantity of grease or oil at regular intervals to ensure uninterrupted production.

In addition, automatic lubricant dispensers can help to optimise lubricant quantities. They can provide efficient lubrication, applying a sufficient lubricant quantity to the friction point at all times.

With a suitable lubricant dispenser and lubricant volumes matching your application, this means that both overlubrication and lubrication starvation are avoided. The friction point is supplied with an optimal lubricant quantity. As it is part of a closed system, it is also protected against harmful effects like those of dust, contamination or moisture.

Single-point lubricant dispensers



Klübermatic FLEX	Page 8
Klübermatic NOVA	Page 9
Klübermatic STAR VARIO	Page 10
Klübermatic STAR CONTROL	Page 11

Multi-point lubricant dispensers



Klübermatic PRO MP-6	Page 12
Klübermatic PRO C MP-6	Page 12
Klübermatic PRO LINE	Page 12
Klübermatic PRO C LINE	Page 12
Klübermatic ECOSY	Page 14

Overview of dispensers and accessories

Overview of Klübermatic	Page 16
Overview of accessories	Page 18
Installation examples	Page 20

Automatic lubrication with Klübermatic – Your benefits at a glance

Every eleven seconds, a lubricating system is installed or replaced somewhere around the world. For those wishing to lubricate their equipment reliably, effectively and cost-efficiently in the long term, automatic lubrication offers obvious benefits. Klüber Lubrication provides a technically and economically optimised solution for every lubrication point.

Enjoy the benefits of Klübermatic

Equipment availability

Klübermatic helps prevent up to 75 % of rolling bearing failures

Premature wear leads to unwanted downtime. The service life of grease-lubricated bearings can be significantly increased with a carefully planned lubrication strategy. With lubrication by means of Klübermatic systems, up to 75 % of all bearing failures can be prevented.

- **Reliable supply of friction points** with fresh lubricant
- **High equipment availability** due to permanent relubrication
- **Reduction of maintenance costs and unplanned equipment downtime**

Klübermatic prevents contamination with fluids or dirt particles

Contamination with water or solid matter encourages wear and decreases bearing life. As automatic lubrication systems feed fresh lubricant, fluids, dirt or dust are prevented from entering the friction point, which enables longer bearing life.

- **Klübermatic** prevents the **ingress** of **dirt particles** and **fluids** into the bearing
- **Protection against friction** and **wear** in the bearing
- **Extension of bearing life**



Automatic lubrication with Klübermatic – Your benefits at a glance

Profitability

Klübermatic can reduce costs by up to 25 %

Klübermatic lubricating systems effectively contribute to cost reduction. With constant, automatic lubrication, premature wear and hence downtime are minimised. Expensive repairs and maintenance are prevented.

- **High equipment availability** due to automated production
- **Plannable maintenance intervals** during standstills
- **Reduction of repair and maintenance costs**



Occupational safety

Klübermatic reduces risk of accidents by up to 90 %

Klübermatic lubricating systems reduce direct contact between workers and machines, contributing decisively towards occupational safety.

- **Less time spent** in hard-to-access, risky areas
- Lubricating systems prevent **direct contact** with lubricants that may be harmful to health
- Less accidents **caused by slipping on ground contaminated with lubricant**



Environmental protection

Klübermatic helps reduce energy and material costs

The environmental management system of Klüber Lubrication is certified acc. to DIN EN ISO 14001. By adjusting the lubricant quantity for each application individually, lubricant consumption is reduced. Reusable, eco-friendly components help minimise the consumption of energy and materials in your company.

- **Reduction of lubricant consumption** through metering to demand
- **No lubricant contamination** due to closed systems
- **Reusable components** help minimise consumption of energy and materials

Work efficiency

Klübermatic simplifies maintenance tasks



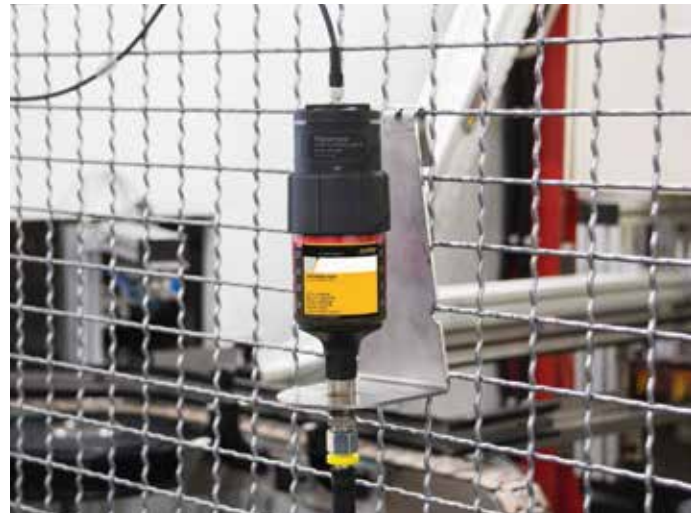

Going from manual lubrication to Klübermatic is simple: wherever there are lubrication points, Klübermatic lubricating systems can be used. Our product range encompasses straightforward single-point lubricant dispensers as well as lubricating system supply up to 600 different friction points individually.

- Dispensing times from **1 day to 24 months**
- Lubricant volume from **30 cm³ to 7000 cm³**
- Service temperature **-20 °C to +60 °C**
- Lubricating systems with high-performance **lubricants up to NLGI 2**



Our product suggestions for your machine elements

Klüber Lubrication provides convincing solutions and always endeavours to reliably supply also those lubrication points that have special requirements.

	Rolling and plain bearings	Chains	Linear guides	Spindles and open gears
Single-point lubricant dispensers				
 <p>FLEX NOVA</p>	✓	✓ ✓	— depending on lubricant	✓
 <p>STAR VARIO STAR CONTROL</p>	✓ ✓	✓ ✓	— depending on lubricant	✓ ✓
Multi-point lubricating systems				
 <p>PRO MP-6 PRO C MP-6</p>	✓ ✓	—	✓ ✓	✓
 <p>PRO LINE PRO C LINE</p>	✓ ✓	—	✓ ✓	✓
 <p>ECOSY</p>	—	✓ ✓	—	✓

— suitable to limited extent

✓ suitable

✓✓ recommended

Our product suggestions for your applications

For many years, Klüber Lubrication has been offering convincing solutions for the lubrication of conveyor belts, electric motors, pumps and fans.

		Conveyor belts	Electric motors	Pumps	Fans
Single-point lubricant dispensers					
	FLEX	✓	✓	✓ ✓	✓ ✓
	NOVA	✓	✓ ✓ *	✓	✓ ✓
	STAR VARIO	✓ ✓	✓ ✓ *	✓ ✓	✓ ✓
	STAR CONTROL	✓	✓ ✓	✓	✓ ✓

– suitable to limited extent

✓ suitable

✓✓ recommended

* for electric motors in areas with explosion protection. Observe back pressure

Klübermatic FLEX

Flexible and compact lubricating system for demanding requirements



Lubricant volume 30 cm³



Lubricant volume 60 cm³



Lubricant volume 125 cm³

Technical information

Drive
Electrochemical reaction

Dispensing time at +20 °C
1,2,3 ... 12 months

Lubricant volume
30 cm³, 60 cm³ or 125 cm³

Service temperature
**-20 °C to +60 °C/
+55 °C (30 cm³)**

Pressure build-up
Max. 5 bar

Protection class
IP 68

Standard and special lubricants
Greases up to NLGI 2/oils

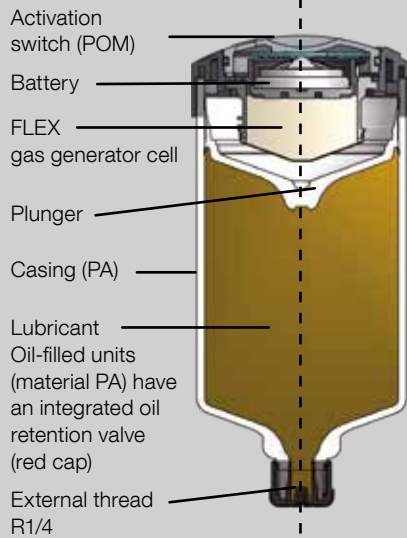

Dimensions FLEX
FLEX 30: Ø 60 x 70 mm
FLEX 60: Ø 58 x 86.5 mm
FLEX 125: Ø 58 x 117 mm

Setting dispensing time in months:

Reference values for emptying without counter pressure with lubricant NLGI 2 for Klübermatic FLEX 125

At temperatures > 40 °C and dispensing times > 6 months, residues may form.



	1	3	6	9	12
at -20 °C	2	5	10	13	15
at 0 °C	1.3	3.8	7.2	11	13
at +20 °C	1	3	6	9	12
at +40 °C	0.8	2.5	5.2	7.5	10
at +60 °C	0.6	2	4	-	-

Product characteristics

Drive by gas generator cell with boost function

Comprehensive system

Explosion protection permission IP 68

Benefits

- Boost function enables rapid lubricant feed
- System is supplied in fully assembled, ready-for-use condition

- Simple adjustment and activation by rotary knob
- Dispensing times can be set in steps of 1 to 12 months

- Safe lubrication in explosion areas
- For environments with high moisture or a lot of dust
- Improves occupational safety

Klübermatic NOVA

First temperature-independent electrochemical lubricating system



Lubricant volume 125 cm³

Technical information

Drive – reusable

Electrochemical reaction based on gas generator cells with electronic temperature compensation

Dispensing time
1, 2, 3 ... 12 months

Lubricant volume
125 cm³

Service temperature
-20 °C to +60 °C

Pressure build-up
Max. 6 bar

Protection class
IP 65

Standard and special lubricants
Greases up to NLGI 2/oils

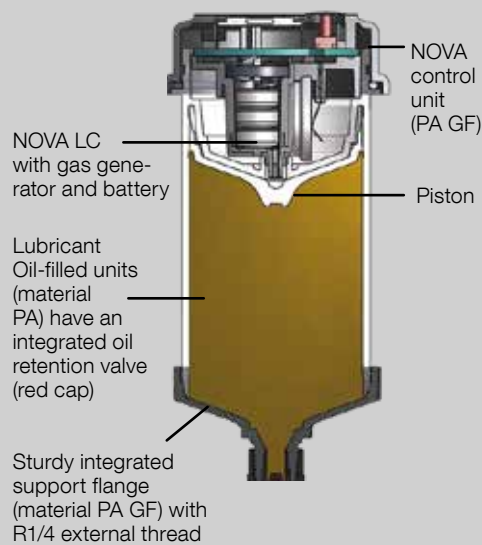

Cover protecting the unit against dust and dirt and during transport



NOVA control unit (material PA GF)
Cover protecting the unit against dust and dirt and during transport



NOVA LC 125

Dimensions
LC 125: Ø 65 x 132 mm

Product characteristics	Your benefits
Temperature compensation	Dispensing time independent from ambient temperature
LC display – easy to use	Easier and safe operation
Wide temperature range	Universal use at both low and elevated temperatures (-20 °C to +60 °C)
For tough conditions	Sturdy unit due to integrated support flange
Explosion protection permission IP 65	Safe lubrication in explosion areas

Klübermatic STAR VARIO

Precision lubricating system offering convenient operation – independent from temperature and back pressure



Lubricant volume 60 cm³



Lubricant volume 120 cm³



Lubricant volume 250 cm³



Lubricant volume 500 cm³

Technical information

Drive – reusable
Electro-mechanical function with battery set STAR VARIO

Dispensing time
1, 2, 3 ... 12 months

Lubricant volume
60 cm³, 120 cm³, 250 cm³ or 500 cm³

Service temperature
-40 °C to +60 °C

Pressure build-up
7,5 bar

Protection class
IP 65

Standard and special lubricants
Greases up to NLGI 2/oils

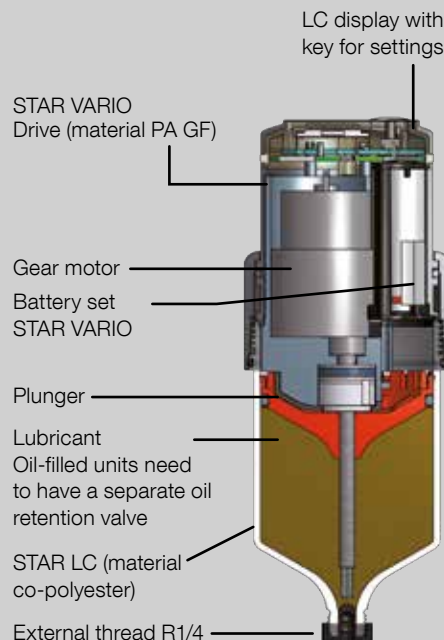

For extreme operating conditions: for LC 60/120 or for LC 250

Klübermatic STAR VARIO drive with protective cover
Setting: 1, 2, 3 ... 12 months
Further variants on request

Battery set STAR VARIO

STAR LC 60, 120, 250, 500

STAR support flange (material PA GF)

Dimensions
LC 60: Ø 75 x 155 mm
LC 120: Ø 75 x 178 mm
LC 250: Ø 75 x 228 mm
LC 500: Ø 75 x 329 mm

Product characteristics	Benefits
Reusable drive	One-time acquisition costs for STAR VARIO Drive
LED (red/green)	Quick control via LED signals saves time and relieves maintenance workers
6 bar system pressure	Allows using remote mounting up to 5 m tube lines for hard to reach areas
Discharge Button	Lubrication point can be purged to clean blockages

Klübermatic STAR CONTROL

TIME and IMPULSE modes combined in a single system



Lubricant volume 60 cm³



Lubricant volume 120 cm³



Lubricant volume 250 cm³

Technical information

Drive – reusable

Electromechanical drive with external power supply: 9–30 V DC, I_{max} 0.5 A

Dispensing time

**Time-controlled (TIME)
Pulse-controlled (IMPULSE)**

Lubricant volume

60 cm³, 120 cm³ or 250 cm³

Service temperature

-20 °C to +60 °C

Pressure build-up

6 bar

Protection class

IP 65

Standard and special lubricants

Greases up to NLGI 2/oils

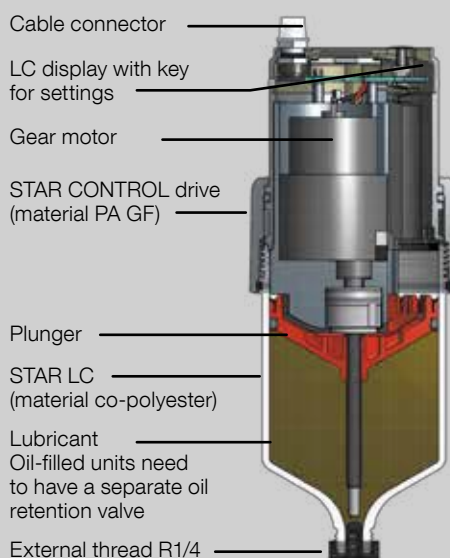

For extreme operating conditions: for LC 60/120 or for LC 250 + adapter cable STAR CONTROL



Connecting cable STAR CONTROL
5 m/10 m



Klübermatic STAR CONTROL drive

– **TIME mode**

Setting: 1, 2, 3 ... 12 months

Further variants on request

– **IMPULSE mode**

Setting: 0.1–9.5 cm³/pulses



STAR LC 60, 120 or 250

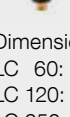

STAR Support flange (material PA GF)

Dimensions

LC 60: Ø 72 x 160 mm

LC 120: Ø 72 x 183 mm

LC 250: Ø 72 x 233 mm

Product characteristics	Your benefits
Electromechanical drive with external power supply	Reliable, precise lubricant release
PLC connection	Operating status can be transmitted to PLC
LC display	Rapid, simple monitoring of settings
Pressure build-up 6 bar	Enables remote setup up to 5 m away
Manual extra-discharge through key	Lubrication point can be flushed to unblock equipment
TIME and IMPULSE OPERATING MODES	In the TIME mode, the dispenser applies lubricant depending on the operating hours. In the IMPULSE mode, a precisely set quantity is applied as soon as the system is connected to power.

Klübermatic PRO MP-6 and PRO C MP-6 and Klübermatic PRO LINE and PRO C LINE



PRO MP-6:
Battery operation



PRO C MP-6:
External power supply

Precision multipoint lubricating system
for up to 6 lubrication points

Klübermatic PRO MP-6 and PRO C MP-6

Product characteristics	Benefits
Setting via push button with display and LED	Simple configuration of dispensing time and outlets Indication of remaining volume and active outlets Status indicated on display
Distributor of MP-6 with 6 outlets – number of active outlets freely selectable	Supply of 1 to 6 lubrication points with the same lubricant quantities
Pressure build-up of max. 25 bar per outlet	Installation outside danger zones or at more accessible locations increases occupational safety and saves time Higher equipment availability as LC can be exchanged during operation Installation at up to 5 m distance possible



PRO LINE: Battery
operation



PRO C LINE:
External power

Self-contained multi-point lubrication
system for max. 6 lubrication points

Klübermatic PRO LINE and PRO C LINE

Product characteristics	Your benefits
Flexible settings for each outlet	Lubricant quantity to be configured for each outlet individually Individual setting of pause times for each outlet individually
Setting via push button with display and LED	Straightforward operation of lubricating system Functional status and any malfunction readily displayed
Dual mode	Operating modes TIME (flexible application per interval) and IMPULSE (flexible application per pulse) as well as dual-mode operation For all outlets extra discharges can be triggered in the pause times

Klübermatic PRO MP-6 and PRO C MP-6 and Klübermatic PRO LINE and PRO C LINE

Technical information		
<p>Drive – reusable PRO MP-6: Battery operation PRO C MP-6: External power supply 15–30 V, 120 mA PRO LINE: Battery operation PRO C LINE: External power supply 15–30 V, 120 mA</p> <p>Dispensing time 1 day up to 24 months</p> <p>Lubricant volume 250 cm³ or 500 cm³</p> <p>Service temperature –20 °C to +60 °C</p> <p>Pressure build-up Max. 25 bar Assembly with tubing < 5 m for each outlet</p> <p>Standard and special lubricants Greases up to NLGI 2</p>	<p>PRO LC (material PC polyester)</p> <p>Support PRO</p> <p>Connecting pieces for tubing Ø 8 mm</p> <p>Distributor PRO MP-6 (material Zn)</p> <p>PRO drive (material Zn)</p> <p>Connecting cable PRO 14 cm</p>	<p>Assemble your Klübermatic PRO system in 3 steps:</p> <ol style="list-style-type: none"> 1. Klübermatic PRO basic system with battery supply or Klübermatic PRO C basic system with external power supply 2. Connecting piece kit PRO 3. PRO LC and cap <p>The grease with which tubings are prefilled must be the same as that of the PRO LC.</p> <p>Dimensions LC 250: Ø 92 x 358 mm LC 500: Ø 92 x 408 mm</p>

Klübermatic ECOSY

Ideal for oil lubrication in demanding applications



Product characteristics	Your benefits
Multifunction display in several languages	Straightforward operation requiring no expertise in programming Individual adjustment of oil quantity per outlet Display showing functions and reserve capacity
High-quality plastic casing with 7 litre volume	Compact and lubricant-resistant plastic casing with integrated lubricant pump and control Reduction of maintenance cost due to long service intervals
Flexible pump control of 6 outlets	Time, sensor or pulse-based control possible Lubricating oils with viscosities 65 to 2,000 mm ² /s (at +40 °C) can be pumped With a powerful pump, even distant and hard-to-access lubrication points can be supplied

Klübermatic ECOSY

Ideal for oil lubrication in demanding applications

Technical information		
<p>Filling volume 7 litres</p> <p>Number of outlets 1 to 6, individual electronic activation</p> <p>Dispensing time Machine-controlled/time-controlled</p> <p>Pumping volume 0–9,999 ml/1,000 h per outlet</p> <p>Service temperature -20 °C to +60 °C</p> <p>Pressure build-up Max. 10 bar</p> <p>Power connection 85–240 V AC, 50–60 Hz 24 V DC, 25 W</p> <p>Standard and special lubricants Oils</p>	<p>ECOSY Housing (material PE)</p> <p>Filter, filling port, screw cap</p> <p>Distributor PRO MP-6</p> <p>Tubing connectors ø 6 mm</p> <p>Pump</p> <p>Motor</p>	<p>Klübermatic ECOSY – Power connection</p> <p>Plug A 85–240 V AC power supply 4-pin</p> <p>Plug B Control & 24 V DC supply 8-pin</p> <p>Dimensions 310 x 380 x 170 mm</p>

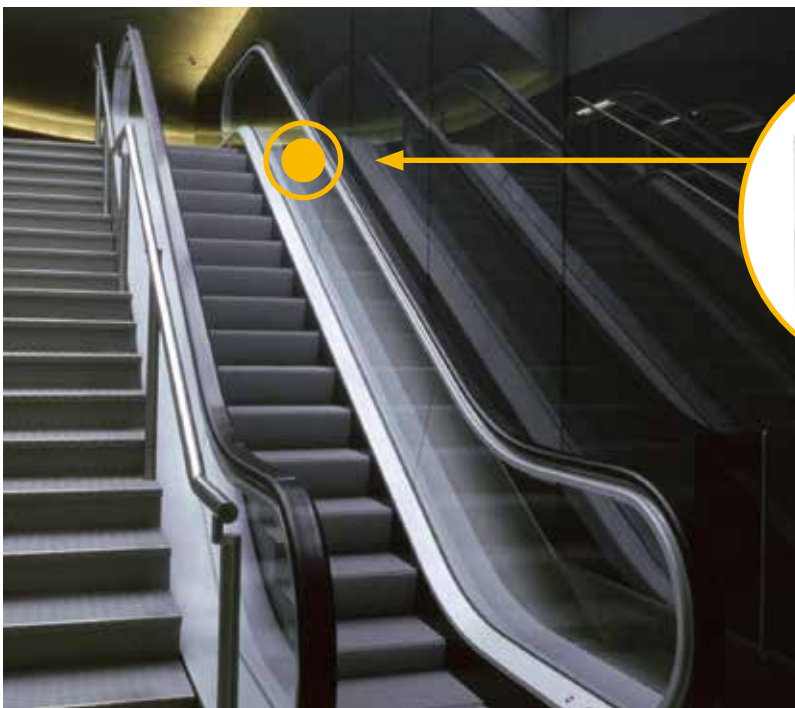













Klübermatic ECOSY can be used for the lubrication of sliding ways as well as drive and conveyor chains. The system can be installed in combination with specially designed brushes to apply the right amount of lubricant at the right point, preventing friction and wear at the contacts areas. This increases equipment life and reduces maintenance costs. Typical applications are in escalators and moving walk conveyors.

Klübermatic overview









Product	Lubricants	Dispensing time	Control	Max. tubing length [m]*	Max. no. of lubricants	Max. pressure [bar]
Single-point lubricant dispensers, electrochemical						
FLEX 60, 125 cm ³		1, 2, 3 ... , 12 months*	Time	<2	1	5
FLEX 30 cm ³	Greases up to NLGI 2/oils	1, 2, 3 ... , 12 months*	Time	<2	1	5
NOVA		1, 2, 3 ... , 12 months*	Time	<2	1	6
Single-point lubricant dispensers, electrochemical						
STAR VARIO		1, 2, 3 ... , 12 months*	Time	<5	1	7,5
STAR CONTROL	Greases up to NLGI 2/Oils	Individual	Time/pulses	<5	1	6
Multi-point lubricating systems, electromechanical						
PRO MP-6		1 day up to 24 months	Time/volume	<5	6	25
PRO C MP-6		Individual	Time/pulses	<5	6	25
PRO LINE	Greases up to NLGI 2	1 day up to 24 months	Time/volume	<5	6	25
PRO C LINE		Individual	Time/pulses	<5	6	25
ECOSY	Oils	Individual	Time/pulses	<10	6	10

* The maximum permissible length of the grease line depends on the lubricating system, the lubricant and the operating temperature.

Klübermatic overview

Product	Service temperature [°C]	Volume [cm ³]	Drive/power supply	Activation/adjustments	Approvals
Single-point lubricant dispensers, electrochemical					
FLEX 60, 125 cm ³	-20 to +60	60 125	Electrochemical/ integrated battery	Rotary switch	   
FLEX 30 cm ³	-20 to +55	30	Electrochemical/ integrated battery and gas generator cell	Rotary switch	  
NOVA	-20 to +60	125	Gas generator cell/ integrated battery	Key for settings with display	  
Single-point lubricant dispensers, electrochemical					
STAR VARIO	-40 to +60	60, 120, 250, 500	Gear motor/battery	Key for settings with display	
STAR CONTROL	-40 to +60	60, 120, 250	Gear motor/9–30 V DC	Key for settings with display	
Multi-point lubricating systems, electromechanical					
PRO MP-6	-20 to +60	250, 500	Gear motor/pump/ battery	Menu control with display	
PRO C MP-6	-20 to +60	250, 500	Gear motor/pump/ 15–30 V DC	Menu control with display	
PRO LINE	-20 to +60	250, 500	Gear motor/pump/ battery	Menu control with display	
PRO C LINE	-20 to +60	250, 500	Gear motor/pump/ 15–30 V DC	Menu control with display	
ECOSY	-20 to +60	7.000	Gear motor/pump 24 V DC/85–240 V AC	Menu control with display	

Overview of accessories

Connecting pieces	Item
	KM NOVA control unit with LC display
	KM STAR VARIO drive KM STAR VARIO battery set KM STAR CONTROL drive 2.0
	KM STAR CONTROL cable 2.0 (5 m) KM STAR CONTROL cable 2.0 (10 m)
	KM STAR support flange G1/4a × G1/4i (brass/plastic)
	KM STAR CONTROL protective cap S60/M120 (plastic)
	KM reducing adapter M6a × G1/4i – brass KM reducing adapter G1/8a × G1/4i – brass KM reducing adapter M8x1a × G1/4i – brass KM reducing adapter M10x1a × G1/4i – brass KM reducing adapter M6a × G1/4i – stainless steel KM reducing adapter G1/8a × G1/4i – stainless steel KM reducing adapter M8x1a × G1/4i – stainless steel KM reducing adapter M10x1a × G1/4i – stainless steel
	KM oil retention valve up to +60 °C (with plastic valve) – brass KM oil retention valve up to +60 °C (with plastic valve) – stainless steel KM oil retention valve up to +150 °C (with metal valve)
	KM angle 45° G1/4a × G1/4i – brass KM angle 90° G1/4a × G1/4i – brass KM angle 45° G1/4a × G1/4i – stainless steel KM angle 90° G1/4a × G1/4i – stainless steel

For further accessories, please contact us.

Overview of accessories

Connecting pieces	Item
	<p>KM extension R1/4a × G1/4i 30 mm – brass</p> <p>KM extension R1/4a × G1/4i 45 mm – brass</p> <p>KM extension R1/4a × G1/4i 75 mm – brass</p> <p>KM extension R1/4a × G1/4i 45 mm – stainless steel</p> <p>KM extension R1/4a × G1/4i 75 mm – stainless steel</p>
	<p>KM tube connection G1/4a straight, tube 8 mm</p> <p>KM tube connection G1/4i straight, tube 8 mm</p>
	<p>KM PSS tube up to +80 °C oØ 8 mm × iØ 6 mm (piece good)</p> <p>KM PTFE tube up to +250 °C oØ 8 mm × iØ 6 mm (piece good)</p> <p>KM tube pre-fill adapter (tube oØ 8 mm) brass</p>
	<p>KM universal clip (for CLASSIC, FUTURA, FLEX, NOVA, STAR)</p> <p>KM insert for bracket – brass</p> <p>KM insert for bracket – stainless steel</p> <p>KM bracket – stainless steel</p>
	<p>KM lubricating brush Ø 20 mm G1/4i</p> <p>KM lubricating brush 40 × 30 mm G1/4i – threaded connector on top</p> <p>KM lubricating brush 60 × 30 mm G1/4i – threaded connector on top</p> <p>KM lubricating brush 100 × 30 mm G1/4i – threaded connector on top</p>
	<p>KM mounting plate 110 × 70 × 2.5 mm – holespacing 45 mm</p> <p>KM mounting angle 50 × 50 × 70 × 2.5 mm – holespacing 45 mm</p> <p>KM mounting angle 50 × 70 × 70 × 2.5 mm – holespacing 45 mm</p> <p>KM mounting angle 50 × 100 × 70 × 2.5 mm – holespacing 45 mm</p>

Installation examples

Multi-point installation (oil)

In order to install the Klübermatic multi-point system for oil (Klübermatic ECOSY), you will need a base system and the accessories listed in the following. You can follow the options for

direct or indirect mounting, depending on your application. You will find the necessary elements on the following page.

Base system multi-point lubrication for oil

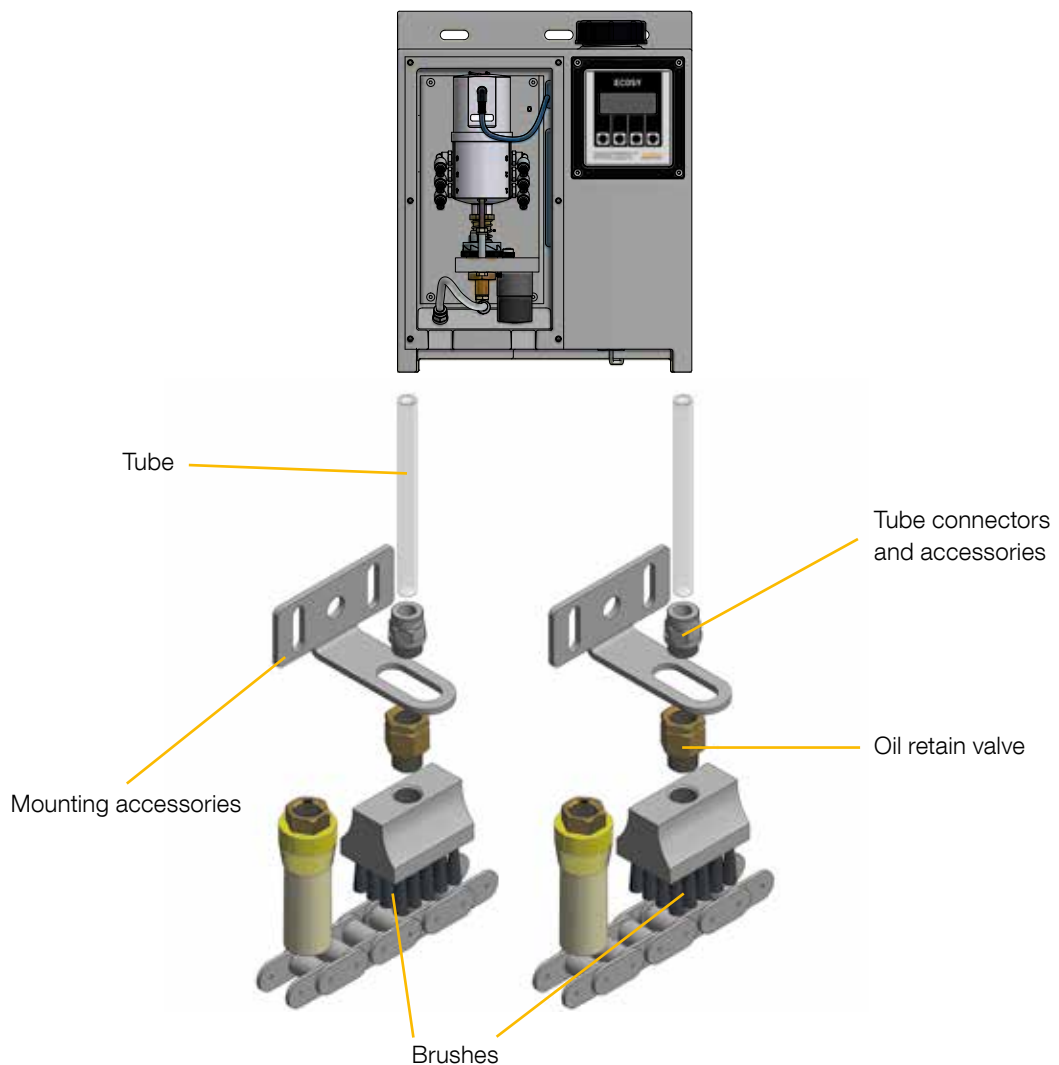

Installation examples

Installation of single-point lubricant dispensers

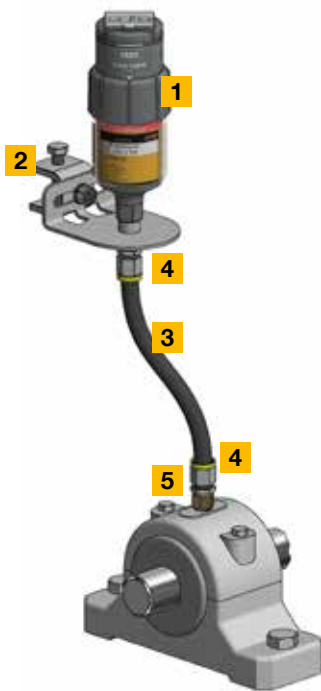

Installation example bearing lubrication

- | | |
|----|---|
| 0 | Accessories for pre-lubrication (not shown) |
| 1 | Klübermatic |
| 2 | Supports/mounting plate/mounting angle |
| 3 | Tubes |
| 4 | Tube connectors |
| 5 | Reducing adapters |
| 6 | Extensions (not shown) |
| 7 | Angles (not shown) |
| 8 | Other (not shown) |
| 9 | Oil retention valves (not shown) |
| 10 | Lubricating brushes (not shown) |

Hint: Avoid overly long lubricating lines. It is best to use tubes with an internal diameter of at least 6 mm.

Chain lubrication: mounted directly to lube point



Bearing lubrication: mounted at some distance

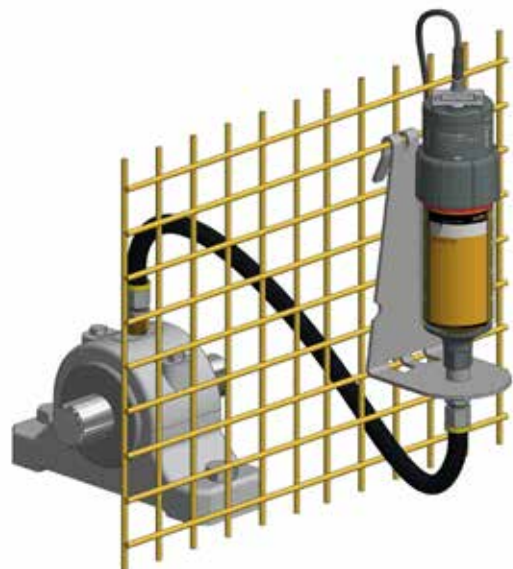



Publisher and Copyright:

Klüber Lubrication München GmbH & Co. KG

Reprints, total or in part, are permitted only prior consultation with Klüber Lubrication München GmbH & Co. KG and if source is indicated and voucher copy is forwarded.

The data in this document is based on our general experience and knowledge at the time of publication and is intended to give information of possible applications to a reader with technical experience. It constitutes neither an assurance of product properties nor does it release the user from the obligation of performing preliminary field tests with the product selected for a specific application. All data are guide values which depend on the lubricant's composition, the intended use and the application method. The technical values of lubricants change depending on the mechanical, dynamical, chemical and thermal loads, time and pressure. These changes may affect the function of a component. We recommend contacting us to discuss your specific application. If possible we will be pleased to provide a sample for testing on request. Products from Klüber Lubrication are continually improved. Therefore, Klüber Lubrication reserves the right to change all the technical data in this document at any time without notice.

Klüber Lubrication München GmbH & Co. KG
Geisenhausenerstraße 7
81379 München
Germany

Local first-instance court Munich, Germany
Certificate of registration 46624

Picture Copyrights:

Titel: © Klüber Lubrication

Seite 3: © perma-tec
© perma-tec

Seite 4: © perma-tec
© Fit Ztudio; shutterstock.com

Seite 5: © Viewfoto studio; shutterstock.com
© perma-tec

Seite 15: © fotolia

Seite 22: © perma-tec

Klüber Lubrication – your global specialist

Innovative tribological solutions are our passion. Through personal contact and consultation, we help our customers to be successful worldwide, in all industries and markets. With our ambitious technical concepts and experienced, competent staff we have been fulfilling increasingly demanding requirements by manufacturing efficient high-performance lubricants for more than 90 years.

www.klueber.com

a brand of
 **FREUDENBERG**